

4 x $\varnothing 20$

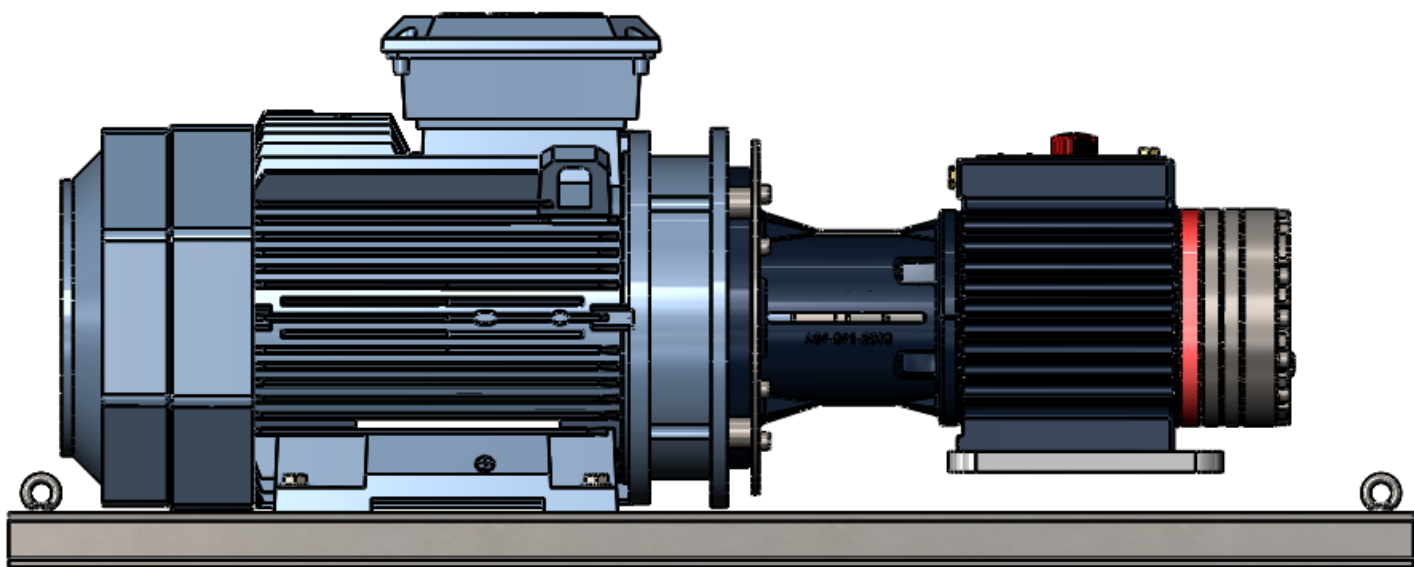

G15 - IEC 180 - MA

331 Kg