

4 x  $\phi 20$

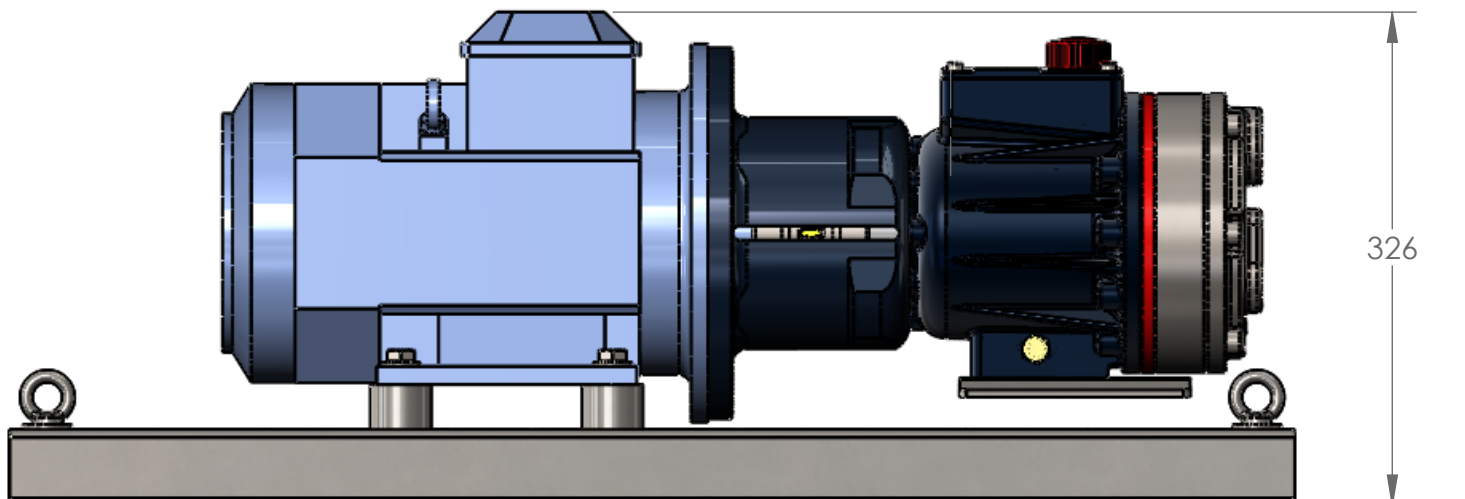

G10 - IEC 100 - MA

78 Kg